

**K10**

for Covering

**E10**

for Elastic band attaching  
(with right hand fabric trimmer)

**U10**

Universal type  
(basic type)

**H10**

for Wider hemming  
Elastic band welting

**E20**

for Endless spandex  
elastic band attaching  
(with manual binder)

**H21**

for Hemming  
(with left hand fabric trimmer)

**E21**

for Endless spandex  
elastic band attaching  
(with air binder)



MF-7823U10B56/UT25

High-speed, Cylinder-bed, Top and Bottom Coverstitch Machine

**MF-7800**  
series

U10

K10

H10

H21

E10

E20

E21

The machine performs sewing that matches a broader range of sewing items.

# MF-7800 series

Soft-seam

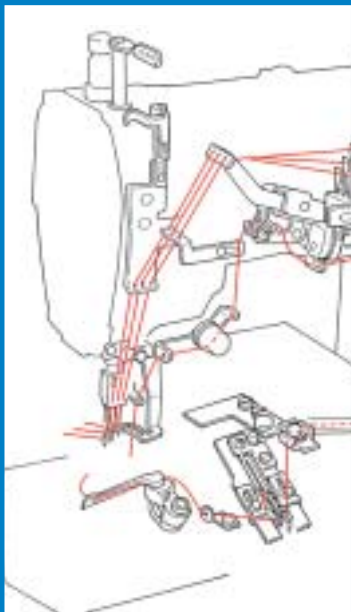

Well-tensed seam

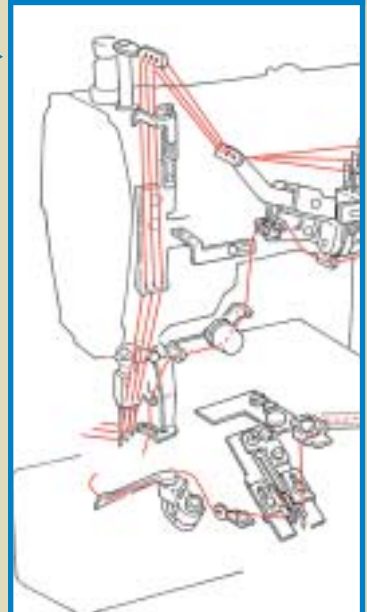

It is possible to select (change over) the stitch type according to sewing items.

It is now possible to change over the stitch type, such as elastic soft-seams for inner wear and high-quality well-tensed seams for outer wear.

\*No thread tension changing is required. The stitch type can be changed over (soft-seams / well-tensed seams) simply by changing the thread path.

Reduction in the thread tension by half contributes to the production of beautifully-finished seams and the achievement of a satisfactory finish of sewing items which snugly fit the skin. In addition, the machine achieves lower vibration and lower noise in consideration of sewing comfort and ease of handling.

# Simplified maintenance mechanism

The machine comes with diverse and trouble-free functions in consideration of the shop-floor.

## Commercially-available gauge components are applicable with no additional work.

As a result of the commonality of components, commercially-available components (presser foot, throat plate and needle clamp) are now applicable and easily obtainable.

## A mechanism for preventing the looper thread from twining around the looper thread cam/looper thread cam shaft.

A V-shaped thread catcher has been installed on the looper thread cam bracket to easily clamp the looper thread, which is likely to twine around the cam.

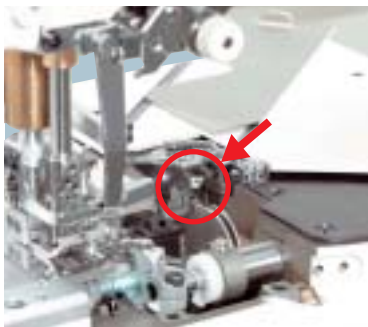

A mechanism where the rotating part of the looper thread cam shaft is covered (hidden) to prevent the looper thread from twining around the cam shaft has been adopted. This mechanism also works to prevent the oil seal from breaking.



## Needle bar stroke conversion mechanism

By changing over the needle bar stroke, penetrating force of the needle as well as thread tension to fit heavy-weight materials (fleece, blankets) can be obtained.

The needle bar stroke can be changed by rotating the eccentric pin. (Changing of parts is not required. Factory-set at the time of delivery: 31mm; for sewing heavy-weight materials: 33mm)

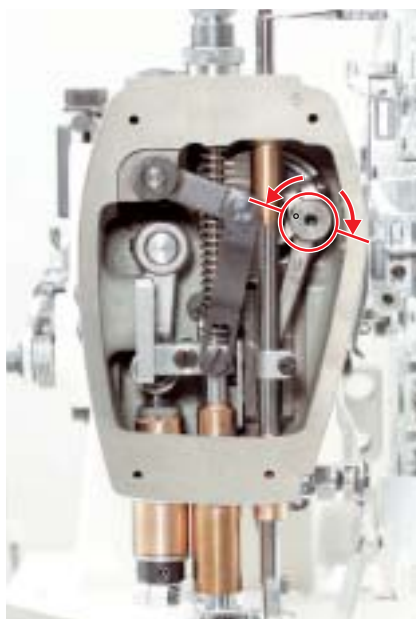

Fleece  
(heavy-weight materials)



Blankets

## Differential-feed micro-adjustment mechanism

It is possible to finely adjust the differential feed amount to a best-suited value for the material to be used. The differential feed ratio is constant even if the stitch length is changed.

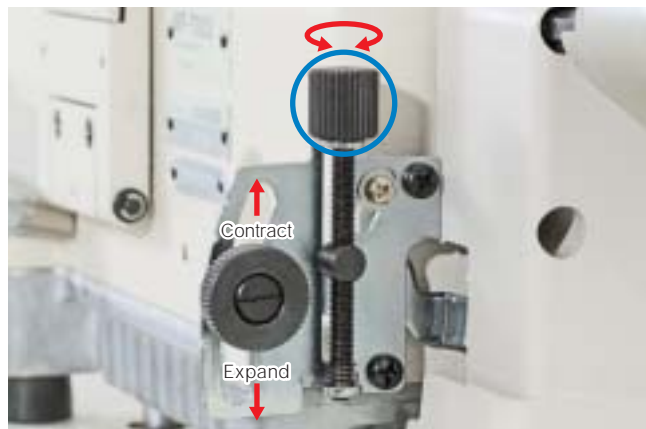
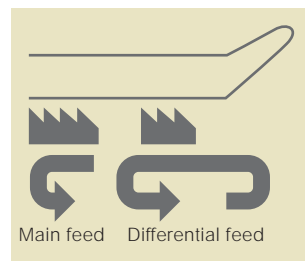

## Micro-lifter mechanism

Elastic material or delicate material can be sewn with the presser foot kept slightly raised. This effectively helps reduce the degree of slippage, warpage and damage of the material.



## Comfortable work space

The cylinder bed is designed to provide a comfortable work space, to secure not only a longer distance from machine arm to needle for covering process so as to help reduce the operator's mental pressure, but also an optimum cylinder length for hemming processes so as to ensure improved operability.

# U10

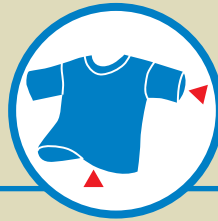

T-shirts

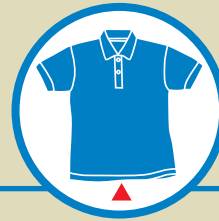

Polo shirts

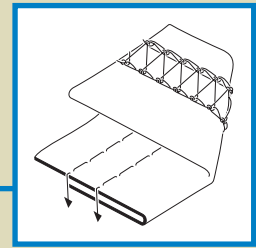

## Universal type (basic type)

The machine can be used for the hemming process of the T-shirts, polo shirts and for the covering process.

It is not a specific-purpose model, but a basic one which can be used for a broader range of processes independently.

\*Modification to the K10 (for covering) is easy.

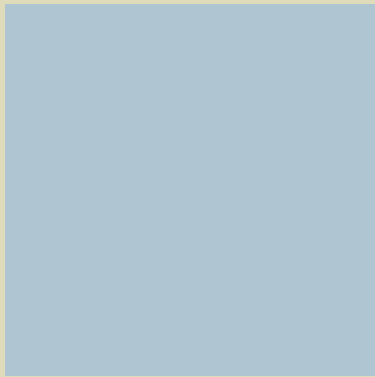

MF-7823U10B56

## List of gauges

Model name	U10			
Needle gauge	4.8mm	5.6mm	6.4mm	
Needle clamp	13350509	13350301		13350400
Throat plate (tonque shape of throat plate)	40040514 ( B type )	40040515 ( B type )	40040516 ( D type )	40040513 ( B type )
Presser foot asm.	13376058	13375050		
Main feed dog	13431200			13430103
Differential-feed dog	13433503			13432109

## List of subclass

Application	Seam	Model No.	Number of needles	Number of threads	Needle gauge (mm)	Stitch length *1 (mm)	Differential-feed ratio	Presser lifting amount *2 (mm)	Max. sewing speed (rpm)
U10 Universal type (basic type)		MF-7822-U10-B48	2	4	4.8	0.9 ~ 3.6	1:0.9 ~ 1:1.8 ( 1:0.6 ~ 1:1.1 )	5( 8 )	6,500
		MF-7822-U10-B48/UT22							
		MF-7823-U10-B**	3	5	5.6, 6.4				
		MF-7823-U10-D56			5.6				
		MF-7823-U10-B**/UT22			5.6, 6.4				
		MF-7823-U10-B**/UT25							
		MF-7823-U10-B**/UT25/SS10							

\*1 Stitch length can be adjusted to 4.5mm at the maximum.

\*2 Differential ratio can be switched by adjustment.

\*3 The numeric value indicates the lifting amount of the presser foot for top and bottom coverstitch.

The numeric value given in parentheses indicates the lifting amount of the presser foot for bottom coverstitch.



# H10

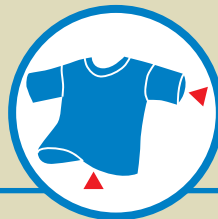

T-shirts

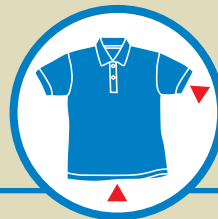

Polo shirts

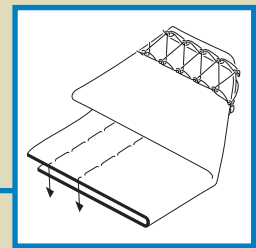

## For wider hemming

H10: This model is best suited to wider hemming processes for T-shirts, Polo shirts, etc.

(Hemming width: Max. 42.9 mm / Needle gauge: 5.6 mm)



Swimwear

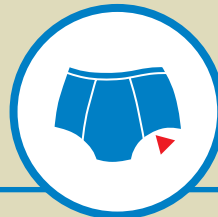

Briefs

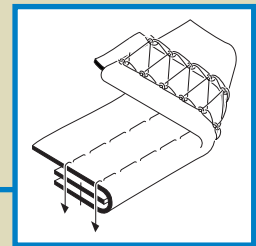

## For elastic band welting

H10 with PL: This model is best suited to elastic-band welting for swimwear, briefs, etc. It welts the elastic band which has been overlapped on the garment body. It comes with a cloth puller.

## H10 with PL



MF-7823H10B56/UT25/PL10

## List of gauges

Model name	H10	
Needle gauge	5.6mm	6.4mm
Needle clamp	13350301	13350400
Throat plate (tongue shape of throat plate)	13355706	13355805
	(B type only)	
Presser foot asm.	40027897	
Main feed dog	13430509	
Differential-feed dog	13432703	

## List of subclass

Application	Seam	Model No.	Number of needles	Number of threads	Needle gauge (mm)	Stitch length *1 (mm)	Differential-feed ratio	Presser lifting amount *2 (mm)	Max. sewing speed (rpm)
<b>H10</b> Wider hemming Elastic band welting		MF-7812-H10-B**/UT24	2	3	5.6, 6.4	0.9 ~ 3.6	1:0.9 ~ 1:1.8 (1:0.6 ~ 1:1.1)	5(8)	6,500
		MF-7823-H10-B**/PL10							5,000
		MF-7823-H10-B**/PL11	3	5					6,500
		MF-7823-H10-B**/UT25							5,000
		MF-7823-H10-B**/UT22/PL10							6,500
		MF-7823-H10-B**/UT25/PL10							5,000
MF-7823-H10-B**/UT25/PL11									

\*1 Stitch length can be adjusted to 4.5mm at the maximum.

\*2 Differential ratio can be switched by adjustment.

\*3 The numeric value indicates the lifting amount of the presser foot for top and bottom coverstitch.

The numeric value given in parentheses indicates the lifting amount of the presser foot for bottom coverstitch.

# H21

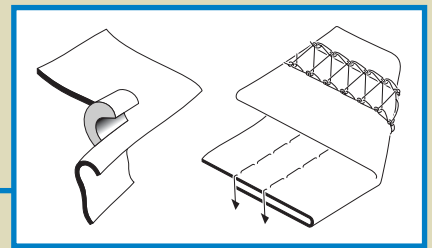
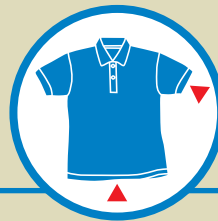

## For Hemming (with left hand fabric trimmer)

T-shirts

Polo shirts

This model is best suited to hemming processes for sleeves and the bottoms of T-shirts, Polo shirts, etc. It comes with a left hand fabric trimmer for trimming fabric in parallel, at all times, to the seam with consistency. The upper knife stroke can be adjusted with ease.

The knife drive section is a unit-structure to permit easy removal. The machine is therefore used as a hemming type model without a trimming capability.



MF-7823H21B56

## List of gauges

Model name	H21		
Needle gauge	4.8mm	5.6mm	6.4mm
Needle clamp	13350509	13350301	13350400
Throat plate (tonque shape of throat plate)	13445101	40041203	40041204
	(B type only)		
Presser foot asm.	40039796	40039794	
Main feed dog	40041249	40032900	
Differential-feed dog	40041233	40040376	
Upper knife	40039364		
Lower knife	40042378		

## List of subclass

Application	Seam	Model No.	Number of needles	Number of threads	Needle gauge (mm)	Stitch length*1 (mm)	Differential-feed ratio	Presser lifting amount*2 (mm)	Max. sewing speed (rpm)
<b>H21</b> Hemming (with left hand fabric trimmer)		MF-7822-H21-B48	2	4	4.8	0.9 ~ 3.6	1:0.9 ~ 1:1.8 (1:0.6 ~ 1:1.1)	5( 8 )	5,500
		MF-7822-H21-B48/MC36							
		MF-7822-H21-B48/UT22							
		MF-7822-H21-B48/UT25							
		MF-7822-H21-B48/UT25/MC35							
		MF-7822-H21-B48/UT25/SS10							
		MF-7823-H21-B**	3	5	5.6, 6.4				
		MF-7823-H21-B**/MC36							
		MF-7823-H21-B**/UT22							
		MF-7823-H21-B**/UT25							
		MF-7823-H21-B**/UT25/SS10							
		MF-7823-H21-B**/UT25/MC35							

\*1 Stitch length can be adjusted to 4.5mm at the maximum.

\*2 Differential ratio can be switched by adjustment.

\*3 The numeric value indicates the lifting amount of the presser foot for top and bottom coverstitch.

The numeric value given in parentheses indicates the lifting amount of the presser foot for bottom coverstitch.

# MF-7800 series

# E10

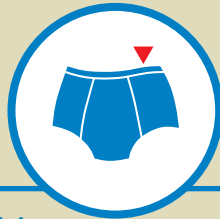

Briefs

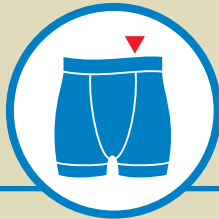

Boxer briefs

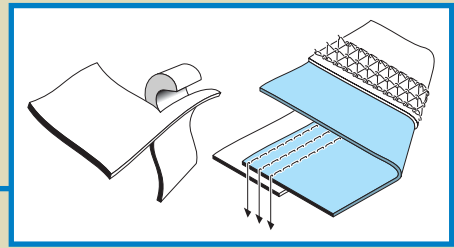

## For elastic band attaching (with right hand fabric trimmer and tension roller)

This model is best suited to endless flat elastic band sewing processes for briefs, boxer briefs, etc. The right hand fabric trimmer trims the fabric, even at a multi-layered joined part, to produce a beautiful finish with the seam and fabric edge aligned with consistency. The right hand fabric trimmer mechanism is a unit-structure to permit easy installation / removal. This contributes to easier adjustments, such as looper aligning.

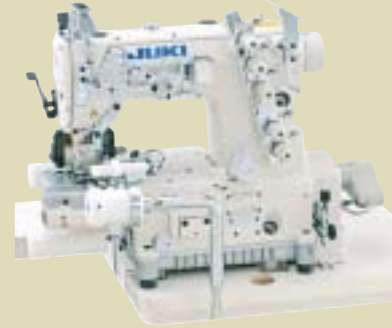
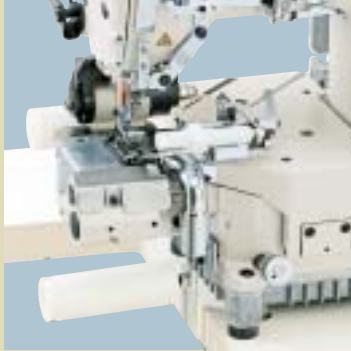

MF-7813E10B56/PL11/MC36

## List of gauges

Model name	E10		
Needle gauge	4.0mm	5.6mm	6.4mm
Needle clamp	13550103	13350301	13350400
Throat plate (tonque shape of throat plate)	13356001	13356209	13356308
	(B type)		
Presser foot asm.	40022100	40022101	
Main feed dog	13430806	13430905	
Differential-feed dog	13433107	13433206	
Upper knife	40038754		
Lower knife	40038091		

## List of subclass

Application	Seam	Model No.	Number of needles	Number of threads	Needle gauge (mm)	Stitch length *1 (mm)	Differential-feed ratio	Presser lifting amount *2 (mm)	Max. sewing speed (rpm)
<b>E10</b> Elastic band attaching (with right hand fabric trimmer)		MF-7822-E10-B40	3	4	4.0	0.9 ~ 3.6	1:0.9 ~ 1:1.8 (1:0.6 ~ 1:1.1)	5(7)	5,500
		MF-7813-E10-B56/PL**/MC36			5.6				5,000
		MF-7813-E10-B**/UT21			5.6, 6.4				5,500
		MF-7813-E10-B**/UT23							
		MF-7813-E10-B**/UT23/MC35							
		MF-7813-E10-B56/UT23/PL10/MC35			5.6				5,000
		MF-7813-E10-B56/UT23/PL11/MC35							
		MF-7813-E10-B56/UT24/PL10/MC35							
		MF-7813-E10-B56/UT24/PL11/MC35			5.6, 6.4				5,500
MF-7823-E10-B**									

\*1 Stitch length can be adjusted to 4.5mm at the maximum.

\*2 Differential ratio can be switched by adjustment.

\*3 The numeric value indicates the lifting amount of the presser foot for top and bottom coverstitch.

The numeric value given in parentheses indicates the lifting amount of the presser foot for bottom coverstitch.



# E20

For endless spandex elastic band attaching  
(with manual binder and tension roller)



Briefs

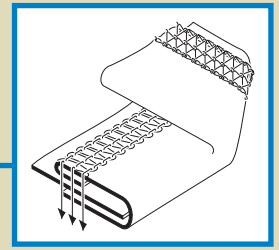

# E21

For endless spandex elastic band attaching  
(with air binder and tension roller)

This model is best suited for sewing elastic bands on briefs. E20 is opened / closed with the knee lever and E21 is opened / closed with the knee switch. The machine comes provided as standard with a tension roller to smoothly sew elastic bands on different-sized garment bodies. The machine flexibly adapts to varying elasticities due to its soft seams.



MF-7823E20B56/PL11



MF-7823E21B56/UT25/PL11

## List of gauges

Model name	E20/21	
Needle gauge	5.6mm	6.4mm
Needle clamp	13350301	13350400
Throat plate (tonque shape of throat plate)	13351606	13351705
	(B type only)	
Presser foot asm.	40037398	
Main feed dog	13430301	
Differential-feed dog	13432307	

## Part No. of binder

Elastic band width (mm)	Part No.	
25	40024766	Option
30	40024767	Option
35	40024768	Standard
40	40024769	Option

## List of subclass

Application	Seam	Model No.	Number of needles	Number of threads	Needle gauge (mm)	Stitch length *1 (mm)	Differential-feed ratio	Presser lifting amount *2 (mm)	Max. sewing speed (rpm)
<b>E20/21</b> Endless spandex elastic band attaching (with binder)		MF-7822-E20-B**/PL11	3	5	5.6, 6.4	0.9 ~ 3.6	1:0.9 ~ 1:1.8 (1:0.6 ~ 1:1.1)	6(7)	5,000
		MF-7822-E21-B**/PL11							
		MF-7823-E20-B**/UT22/PL11							
		MF-7823-E21-B**/UT25/PL11							

\*1 Stitch length can be adjusted to 4.5mm at the maximum.

\*2 Differential ratio can be switched by adjustment.

\*3 The numeric value indicates the lifting amount of the presser foot for top and bottom coverstitch.

The numeric value given in parentheses indicates the lifting amount of the presser foot for bottom coverstitch.

## WHEN YOU PLACE ORDERS

Please note when placing orders, that the model name should be written as follows:

### [without automatic thread trimmer]

Stitch type	Code
3-needle, bottom coverstitch	13
2-needle, top and bottom coverstitch	22
3-needle, top and bottom coverstitch	23

Tonque shape of throat plate	Code
B type (standard)	B
D type	D

\*D: This gives a moderate slack to the needle thread as compared with the standard type B.

**MF78**

Application	Code
Universal	U10
Covering	K10
Wider hemming / Elastic band wetting	H10
Hemming (with left hand fabric trimmer)	H21
Elastic band attaching (with right hand fabric trimmer)	E10
Endless spandex elastic band attaching (with manual binder)	E20
Endless spandex elastic band attaching (with air binder)	E21

Needle gauge	Code
4.0mm	40
4.8mm	48
5.6mm	56
6.4mm	64

\*For model category (13, 23) (3-needle), needle gauge category 40 and 48 cannot be selected.

Device and attachment	Code
Not provided	
Pneumatic cloth chip suction device (mechanical valve type)	MC36
Cloth puller: Gear type	PL10
Cloth puller: Flat type	PL11

### [with automatic thread trimmer]

Stitch type	Code
2-needle, bottom coverstitch	12
3-needle, bottom coverstitch	13
2-needle, top and bottom coverstitch	22
3-needle, top and bottom coverstitch	23

Tonque shape of throat plate	Code
B type (standard)	B

Thread trimming device	Code
Electromagnetic type bottom thread trimming device + Electromagnetic type wiper	UT21
Electromagnetic type top and bottom thread trimming device	UT22
Pneumatic type bottom thread trimming device +Electromagnetic type wiper	UT23
Pneumatic type bottom thread trimming device +Air blow type wiper	UT24
Pneumatic top and bottom thread trimming device	UT25

**MF78**

**B**

**/UT**

Application	Code
Universal	U10
Covering	K10
Wider hemming / Elastic band wetting	H10
Hemming (with left hand fabric trimmer)	H21
Elastic band attaching (with right hand fabric trimmer)	E10
Endless spandex elastic band attaching (with manual binder)	E20
Endless spandex elastic band attaching (with air binder)	E21

Needle gauge	Code
4.8mm	48
5.6mm	56
6.4mm	64

\*For model category (13, 23) (3-needle), needle gauge category 48 cannot be selected.

Device and attachment	Code
Not provided	
Short stitch device (pneumatic type)	SS10
Pneumatic cloth chip suction device (electromagnetic valve type)	MC35
Pneumatic cloth chip suction device (mechanical valve type)	MC36
Cloth puller: Gear type	PL10
Cloth puller: Flat type	PL11

### [Control box / Motor]

Thread trimming device Device and attachment	Control box / Motor	
	SC-500/M50	SC-510/M51
UT21		
UT22		
UT23		
UT24		
UT25		
UT /SS10		
UT /MC35		
UT /SS10/MC35		

\*The maximum sewing speed is less than 5,500rpm when using SC-500/M50.

To order, please contact your nearest JUKI distributor.

## Common specifications (U10, K10, H10, H21, E10, E20, E21)

Model name		MF-7800 series	
Stitch type	2-needle / 3-needle top and bottom covering stitch		
Needle	UY128GAS #9S ~ #14S (standard #10S)		
Lift of the presser foot	U10, K10, H10, H21	5mm (with top and bottom covering stitch), 8mm (with bottom covering stitch)	
	E10	5mm (with top and bottom covering stitch), 7mm (with bottom covering stitch)	
	E20, E21	6mm (with top and bottom covering stitch), 7mm (with bottom covering stitch)	
Stitch pitch adjustment	By dial		
Differential feed adjustment	By micro-adjustment mechanism		
Lubrication	Automatic		
Lubricating oil	JUKI MACHINE OIL 18 (equivalent to ISO VG18)		
Feed dog inclination adjustment	Provided as standard		
Micro-lifter	Provided as standard		
Needle bar stroke converting function	Provided as standard	31mm: at the time of delivery (U10, K10, H10, H21, E10)	
		33mm: at the time of delivery (E20, E21)	
Silicon oil tank for needle tip and needle thread	Provided as standard		
Cartridge oil filter	Provided as standard		
Weight of the machine head	U10	42kg (without device), 44kg (with UT25), 48kg (with UT22)	
	K10	42kg (without device), 44kg (with UT25), 48kg (with UT22)	
	H10	44kg (with UT24/UT25), 47kg (with PL), 53kg (with UT22, PL)	
	H21	43kg (without device), 45kg (with UT25) , 49kg (with UT22)	
	E10	43kg (without device), 45kg (with UT23), 48kg (with PL), 49kg (with UT21), 50kg (with UT23/PL), 50kg (with UT24/PL)	
	E20	50kg (with PL), 56kg (with UT22/PL)	
	E21	48kg (with PL), 50kg (with UT25/PL)	

## Control box / AC servomotor

### SC-510/M51【High-speed type】

The machine has excellent high-speed sewing performance and a strong cloth-penetrating force. The machine therefore demonstrates a broader range of applicability, from general fabric to extra heavy-weight materials.

The machine has been provided with a high-torque AC servomotor (M51) with an output of 750 W, thereby achieving a sufficient torque performance.

The number of revolutions at startup can be selected from among three different ones (standard, slow, rapid) as the operator desires.

A control box has been provided with a simplified programming capability. Four different programs can be operating at one time. Twenty operation steps can be entered in one program.

For example, devices such as a suction unit can be operated while additional capabilities such as the stacker function can be used with the program.

\*Input / output ports which can be used by the customer as desired (8 input ports and 8 output ports)



## UT21

Electromagnetic type bottom thread trimming device  
+ Electromagnetic type wiper / Auto-lifter

This is an electromagnetic type bottom thread trimming device / auto-lifter. It is used for processes which do not need top covering.



Electromagnetic type wiper

## UT22

Electromagnetic type top and bottom thread trimming device / Auto-lifter

It is an electromagnetic type automatic top and bottom thread trimming device / auto-lifter. The machine does not need an air compressor to achieve easy layout changing.



Electromagnetic type top and bottom thread trimming device



1 Presser lifter drive mechanism magnet  
2 Thread trimmer drive mechanism magnet

## UT23

Pneumatic type bottom thread trimming device  
+ Electromagnetic type wiper / Auto-lifter

This is a pneumatic type bottom thread trimming device / auto-lifter. It is used for processes which do not need top covering.



Pneumatic type bottom thread trimming device

## UT24

Pneumatic type bottom thread trimming device +  
Air blow type wiper / Auto-lifter

This is a pneumatic type bottom thread trimming device / auto-lifter. It pneumatically handles the needle thread (i.e, places the needle thread above the presser foot) instead of the mechanical wiper.

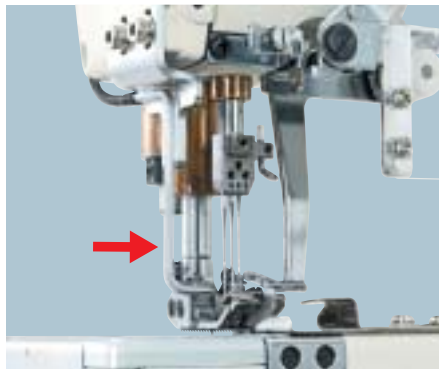

Air blow type wiper

## UT25

Pneumatic top and bottom thread trimming device / Auto-lifter

It is a pneumatic automatic thread trimming device / auto-lifter. Since the automatic lift of the presser foot and automatic thread trimming can be activated by lightly depressing the pedal, work efficiency is dramatically increased.



Pneumatic top and bottom thread trimming device

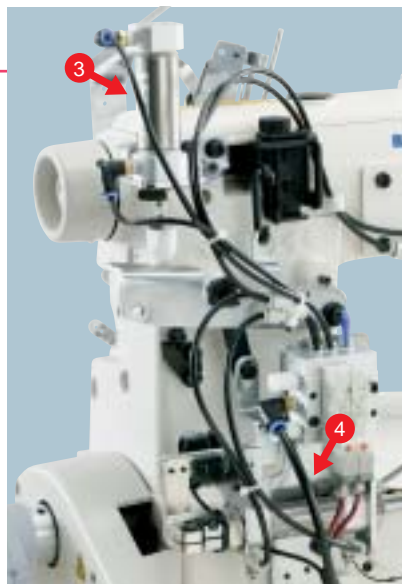

3 Presser lifter drive mechanism air cylinder 4 Thread trimmer drive mechanism air cylinder

## MC35 • 36 Pneumatic cloth chip suction device

MC35 (solenoid valve type), MC36 (mechanical valve type)

Cloth chips trimmed by the hook knife are sucked away using air. So, there is no risk of sewing cloth chips in seams.

MC35 (solenoid valve type) for the servomotor or MC36 (mechanical valve type) for the clutch motor should be selected according to the use of your machine.



MC35



MC36

## SS10 Short stitch device

This is a device for preventing the thread from coming undone at the end of sewing. The device is able to sew condensation stitches by the number specified as desired. It prevents the needle thread from being poorly tensed, which is likely to occur in cases where the amount of condensation is reduced.



The needle thread tightening mechanism helps produce well-tensed seams even when the machine performs short stitching.



The short stitch pitch can be adjusted with ease.



## PL10 Cloth puller: Gear type

This is a gear type cloth puller. It helps feed difficult-to-feed materials to assist smooth sewing.

(Example: Attaching flat elastic bands)



## PL11 Cloth puller: Flat type

This is a flat type cloth puller. It helps feed soft material which requires a higher feeding force to assist sewing.

(Example: Hemming)



### Compressed air / Air consumption (with automatic thread trimmer)

UT24			Air consumption dm <sup>3</sup> /min (ANR)	Compressed air MPa
Bottom thread trimmer / Auto-lifter	Air-blow type wiper	MC35 MC36		
			182	0.5
			637	

UT25			Air consumption dm <sup>3</sup> /min (ANR)	Compressed air MPa
Top and bottom thread trimmer / Auto-lifter	Air-blow type wiper	MC35 MC36		
			0.7	0.5
			182	
			456	
			637	

**JUKI**® 8-2-1, KOKURYO-CHO, CHOFU-SHI,  
TOKYO 182-8655, JAPAN  
PHONE : (81) 3-3480-2357, 2358  
FAX : (81) 3-3430-4909, 4914  
MARKETING & SALES H.Q. <http://www.juki.com>

- \* Specifications and appearance are subject to change without prior notice for improvement.
- \* Read the instruction manual before putting the machine into service to ensure safety.
- \* This catalogue prints with environment-friendly soyink on recycle paper.



**JUKI CORPORATION HEAD OFFICE**

The environmental management system to promote and conduct  
① the technological and technical research, the development and design of the products in which the environmental impact is considered.

② the conservation of the energy and resources, and the recycling, in the research, development, design, distribution, sale and maintenance service of the industrial sewing machines, household sewing machines and industrial-use robots, etc., and in the sale and maintenance service of the data entry system and in the purchase, distribution and sale of the household commodities including the healthcare products.